

**This Strata Plan is compiled from the Developer's Disclosure Statement. The Actual Registered Strata Plan May Vary From These Plans.**

The Webmaster, REMAX Crest Realty (Westside), Les Twarog, Sonja Pedersen are not held liable for any errors or omissions. The reader of this material to verify the accuracy of the content.

www.BCStrataPlans.com

**YALETOWN PARK – 1 & 2**

**DISCLOSURE STATEMENT**

Date: February 20, 2004

- A. Developer: Yaletown Park Condominium Properties Ltd.
- B. Address for Service: c/o McLachlan Brown Anderson  
Barristers & Solicitors  
10th Floor, 938 Howe Street  
Vancouver, British Columbia  
V6Z 1N9
- C. Developer's Mailing Address: c/o 35th Floor, 1088 Burrard Street  
Vancouver, British Columbia  
V6Z 2R9
- D. Real Estate Agent: Rennie Marketing Systems  
1054 Hornby Street  
Vancouver, British Columbia  
V6Z 1V6

The Developer reserves the right to appoint additional or replacement agents or subagents.

**DISCLAIMER**

NEITHER THE SUPERINTENDENT OF REAL ESTATE NOR ANY OTHER AUTHORITY OF THE GOVERNMENT OF BRITISH COLUMBIA HAS IN ANY WAY PASSED ON THE MERITS OF THE MATTERS DEALT WITH IN THIS DISCLOSURE STATEMENT. THIS DISCLOSURE STATEMENT HAS BEEN FILED WITH THE SUPERINTENDENT OF REAL ESTATE, BUT HE HAS NOT DETERMINED WHETHER OR NOT IT COMPLIES WITH PART 2 OF THE *REAL ESTATE ACT*.

PROPOSED STRATA OF  
 AIRSPACE PARCEL 1, BLOCK 76, D.L. 541,  
 GROUP 1, N.W.D., AIRSPACE PLAN BCP

STRATA PLAN BCS \_\_\_\_\_

"CITY OF VANCOUVER"

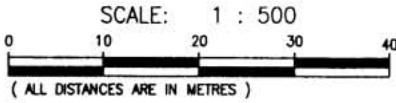

**LEGEND**

- m<sup>2</sup> DENOTES SQUARE METRES
- S.F. DENOTES SQUARE FEET
- S.L. DENOTES STRATA LOT
- LCP DENOTES LIMITED COMMON PROPERTY
- VEST. DENOTES VESTIBULE
- PB DENOTES PARKING BAY
- SA DENOTES STORAGE AREA
- BS DENOTES BICYCLE STORAGE
- © DENOTES COMMON PROPERTY

**METHOD OF MEASUREMENT**

- TO CENTRELINE OF ALL DEMISING WALLS BETWEEN STRATA LOTS AND CORE WALLS (IE, ELEVATOR, STAIRWELL).
- TO ONE (1) CENTIMETRE INSIDE OF THE OUTSIDE FACE OF EXTERIOR WALL AND ALL STRATA LOT WALLS ADJOINING COMMON AREAS (IE CORRIDOR WALL).

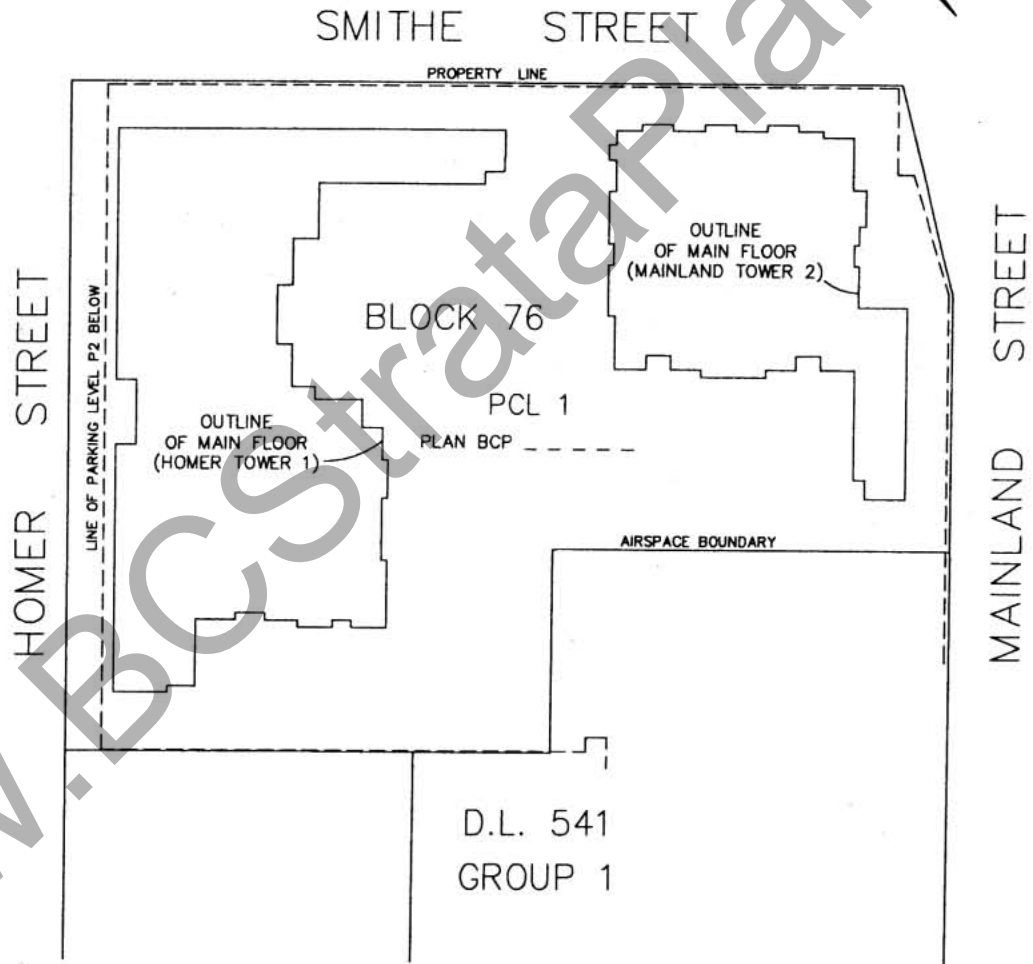

**NOTE:**

INFORMATION SHOWN ON THIS PLAN IS DERIVED FROM ARCHITECTURAL DRAWINGS AND MAY CHANGE UPON PROJECT COMPLETION.



**McElhanney**

FEBRUARY 16, 2004  
 FILE 2112 06911-12R1

# PARKING LEVEL 6

STRATA PLAN BCS \_\_\_\_\_

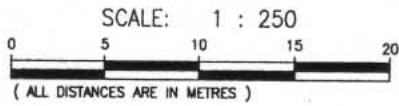

SMITHE STREET

PROPERTY LINE

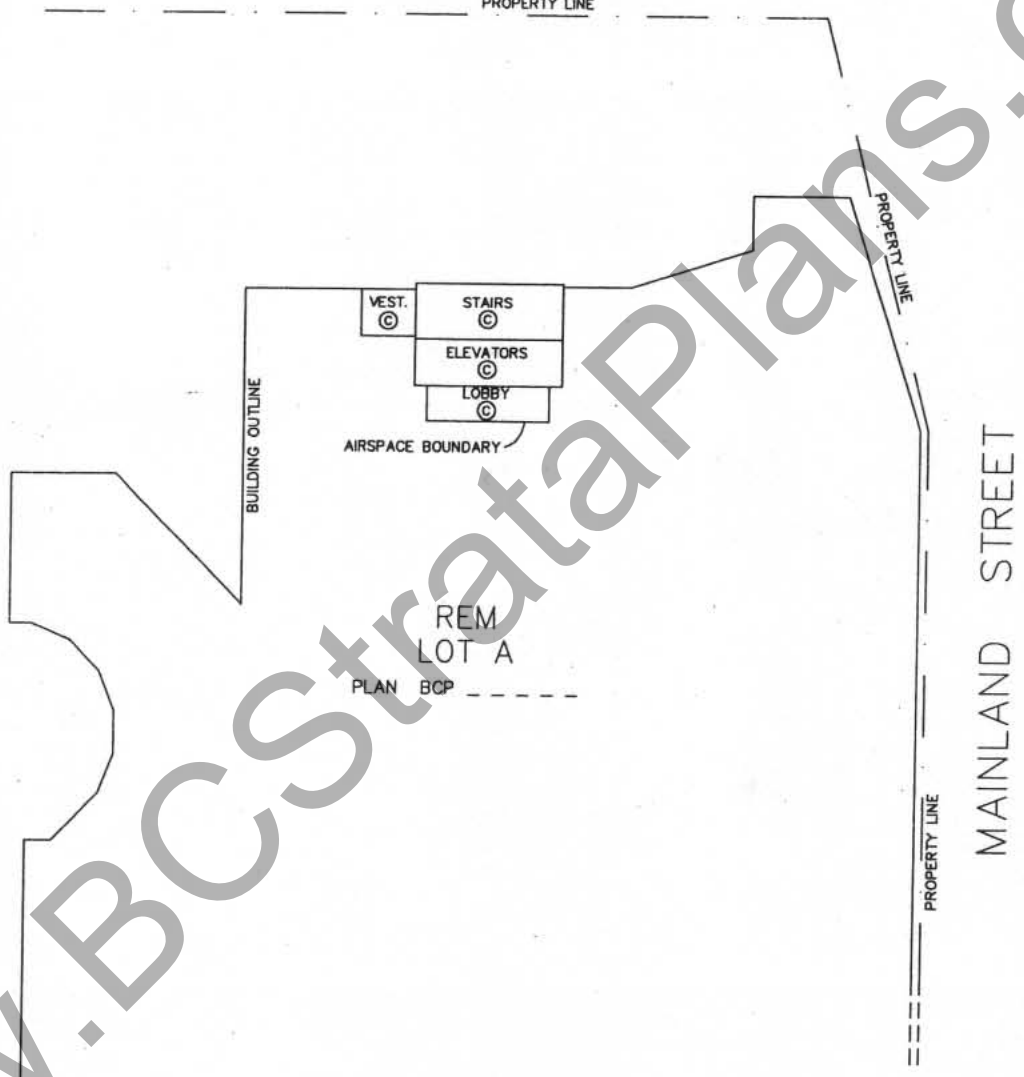

MAINLAND STREET

PROPERTY LINE



**McElhanney**

FEBRUARY 16, 2004  
FILE 2112 06911-12R1

# PARKING LEVEL 5

STRATA PLAN BCS \_\_\_\_\_

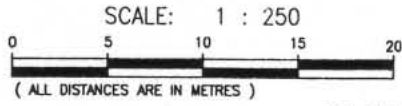

FOR CONTINUATION  
SEE SHEET 4

## SMITHE STREET

PROPERTY LINE

BUILDING OUTLINE

REM  
LOT A  
PLAN BCP \_\_\_\_\_

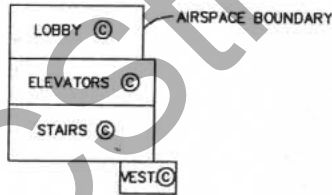

PROPERTY LINE

B  
PLAN 4544

REM LOT A  
PLAN BCP \_\_\_\_\_  
SRW PLAN BCP \_\_\_\_\_

FOR CONTINUATION  
SEE SHEET 4



**McElhanney**

FEBRUARY 16, 2004  
FILE 2112 06911-12R1

# PARKING LEVEL 5

STRATA PLAN BCS \_\_\_\_\_

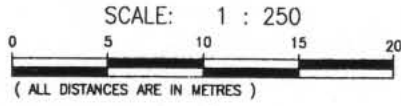

SEE SHEET 3 FOR CONTINUATION

## SMITHE STREET

PROPERTY LINE

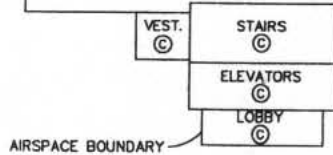

PROPERTY LINE

### REM LOT A

PLAN BCP \_\_\_\_\_

## MAINLAND STREET

BUILDING OUTLINE  
PROPERTY LINE

### REM LOT A

PLAN BCP \_\_\_\_\_

SRW PLAN BCP \_\_\_\_\_

SEE SHEET 3 FOR CONTINUATION



**McElhanney**

FEBRUARY 16, 2004  
FILE 2112 06911-12R1

# PARKING LEVEL 4

STRATA PLAN BCS \_\_\_\_\_

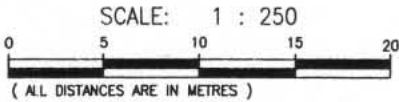

FOR CONTINUATION  
SEE SHEET 6

## SMITHE STREET

PROPERTY LINE

BUILDING OUTLINE

### REM LOT A

PLAN BCP \_\_\_\_\_

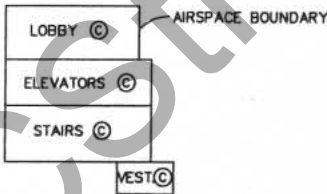

PROPERTY LINE

B  
PLAN 4544

REM LOT A  
 PLAN BCP \_\_\_\_\_  
 SRW PLAN BCP \_\_\_\_\_

FOR CONTINUATION  
SEE SHEET 6



**McElhanney**  
 FEBRUARY 16, 2004  
 FILE 2112 06911-12R1

# PARKING LEVEL 4

STRATA PLAN BCS \_\_\_\_\_

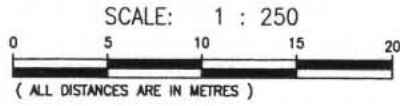

SEE SHEET 5 FOR CONTINUATION

## SMITHE STREET

PROPERTY LINE

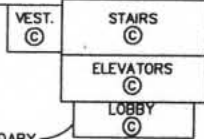

AIRSPACE BOUNDARY

PROPERTY LINE

### REM LOT A

PLAN BCP \_\_\_\_\_

## MAINLAND STREET

BUILDING OUTLINE  
PROPERTY LINE

REM LOT A  
PLAN BCP \_\_\_\_\_  
SRW PLAN BCP \_\_\_\_\_

SEE SHEET 5 FOR CONTINUATION



**McElhanney**  
FEBRUARY 16, 2004  
FILE 2112 06911-12R1



# PARKING LEVEL 3

STRATA PLAN BCS \_\_\_\_\_

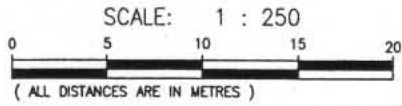

FOR CONTINUATION  
SEE SHEET 8

## SMITHE STREET

PROPERTY LINE

BUILDING OUTLINE

REM  
LOT A  
PLAN BCP -----

AIRSPACE BOUNDARY

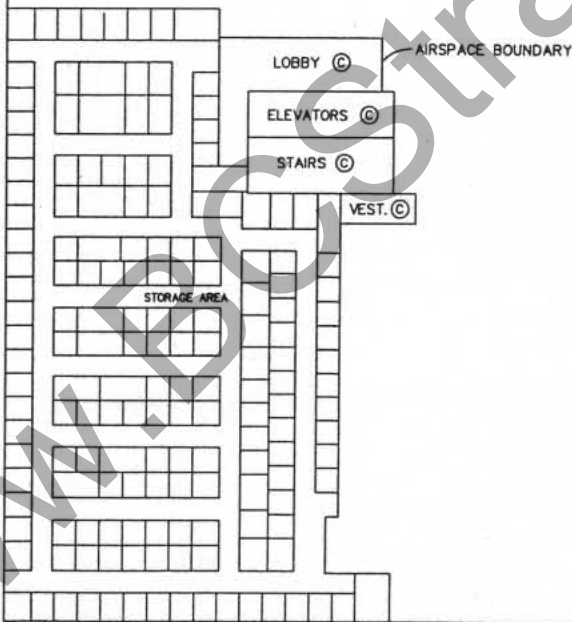
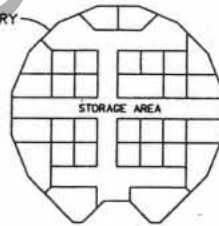

PROPERTY LINE

B  
PLAN 4544

REM LOT A  
PLAN BCP -----  
SRW PLAN BCP -----

FOR CONTINUATION  
SEE SHEET 8



**McElhanney**

FEBRUARY 16, 2004  
FILE 2112 06911-12R1

# PARKING LEVEL 3

STRATA PLAN BCS \_\_\_\_\_

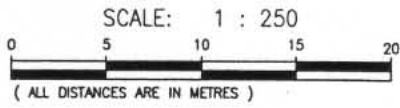

SEE SHEET 7  
FOR CONTINUATION

## SMITHE STREET

PROPERTY LINE

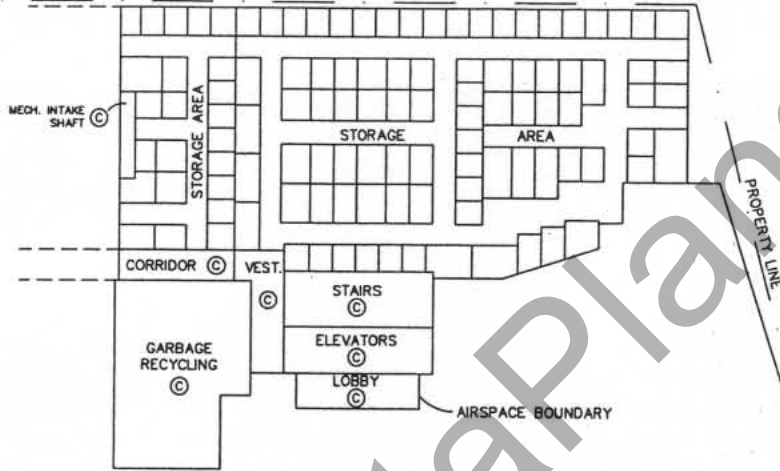

PROPERTY LINE

REM  
LOT A

PLAN BCP

BUILDING OUTLINE  
PROPERTY LINE

MAINLAND STREET

REM LOT A

PLAN BCP

SRW PLAN BCP

SEE SHEET 7  
FOR CONTINUATION



**McElhanney**

FEBRUARY 16, 2004  
FILE 2112 06911-12R1

# PARKING LEVEL 2

STRATA PLAN BCS \_\_\_\_\_

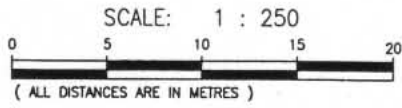

## SMITHE STREET

PROPERTY LINE

FOR CONTINUATION  
SEE SHEET 10

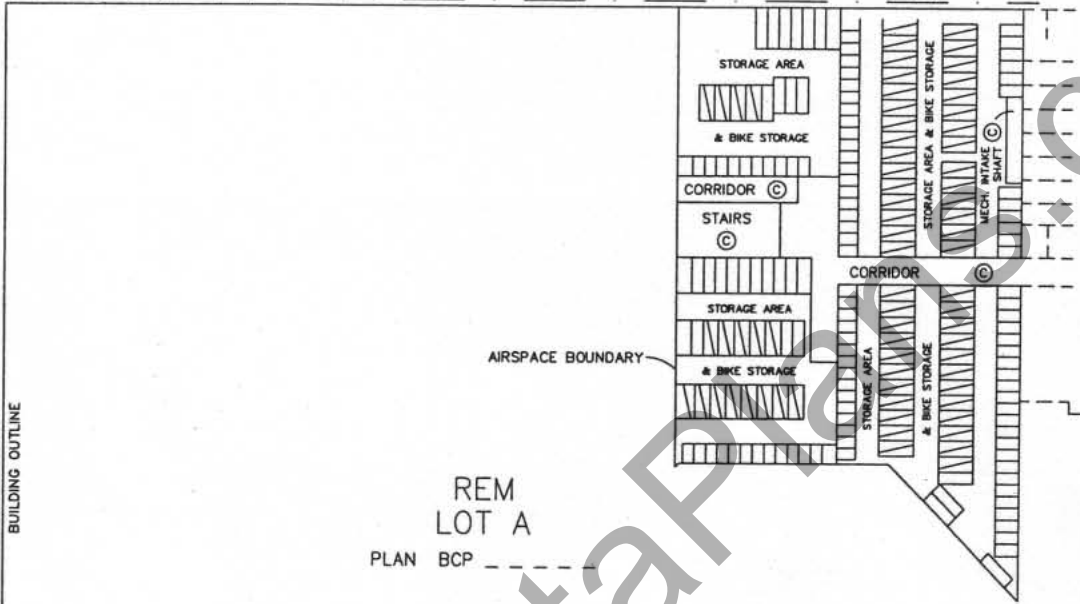

REM  
LOT A  
PLAN BCP - - - - -

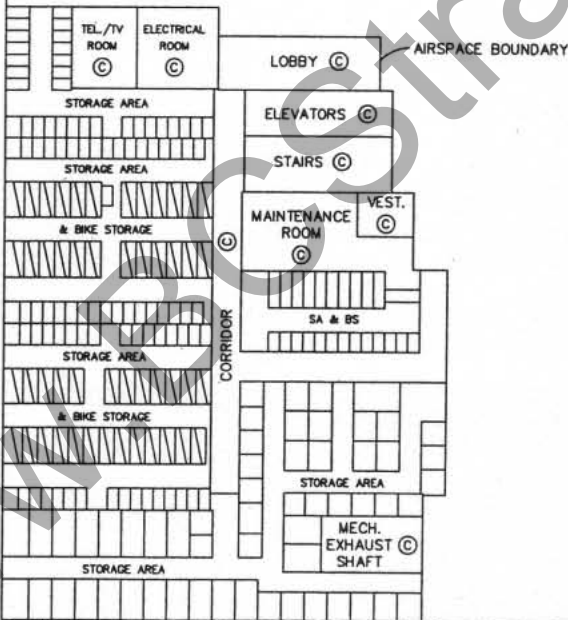

B  
PLAN 4544

BUILDING OUTLINE

REM LOT A  
PLAN BCP - - - - -  
SRW PLAN BCP - - - - -

FOR CONTINUATION  
SEE SHEET 10

**McElhanney**

FEBRUARY 16, 2004  
FILE 2112 06911-12R1

# PARKING LEVEL 2

STRATA PLAN BCS \_\_\_\_\_

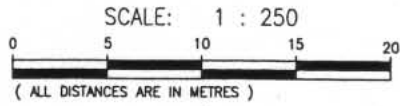

SEE SHEET 9 FOR CONTINUATION

## SMITHE STREET

PROPERTY LINE

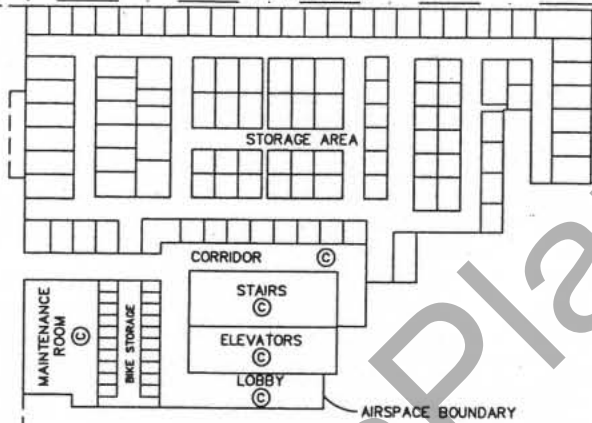

PROPERTY LINE

## MAINLAND STREET

BUILDING OUTLINE  
PROPERTY LINE

### REM LOT A

PLAN BCP \_\_\_\_\_

### REM LOT A

PLAN BCP \_\_\_\_\_

SRW PLAN BCP \_\_\_\_\_

SEE SHEET 9 FOR CONTINUATION



**McElhanney**

FEBRUARY 16, 2004  
FILE 2112 06911-12R1

# MEZZANINE LEVEL

STRATA PLAN BCS \_\_\_\_\_

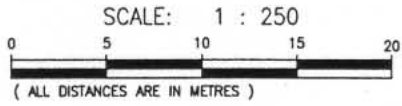

## SMITHE STREET

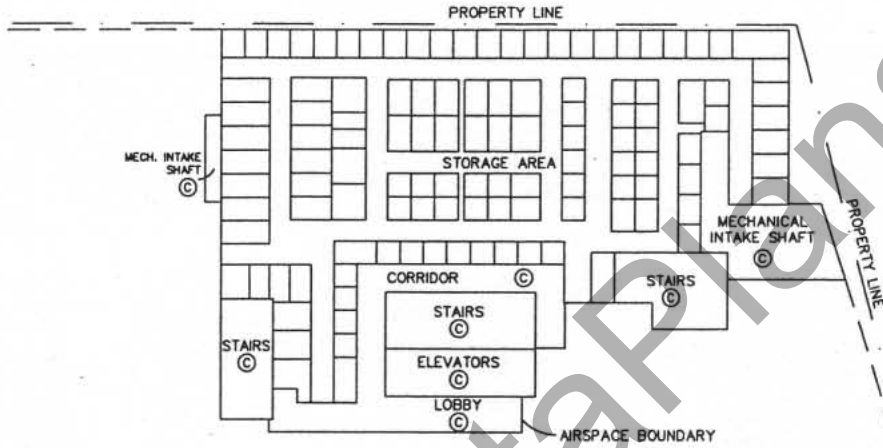

REM  
LOT A

PLAN BCP \_\_\_\_\_

MAINLAND STREET

PARKING LEVEL 2 BELOW  
PROPERTY LINE

www.BCStrataPlans.com



**McElhanney**

FEBRUARY 16, 2004  
FILE 2112 06911-12R1

# PARKING LEVEL 1 AND MAINLAND TOWER 2 - LEVEL 1

STRATA PLAN BCS \_\_\_\_\_

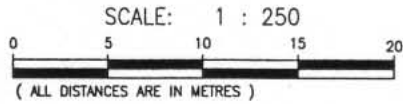

FOR CONTINUATION  
SEE SHEET 13

## SMITHE STREET

PROPERTY LINE

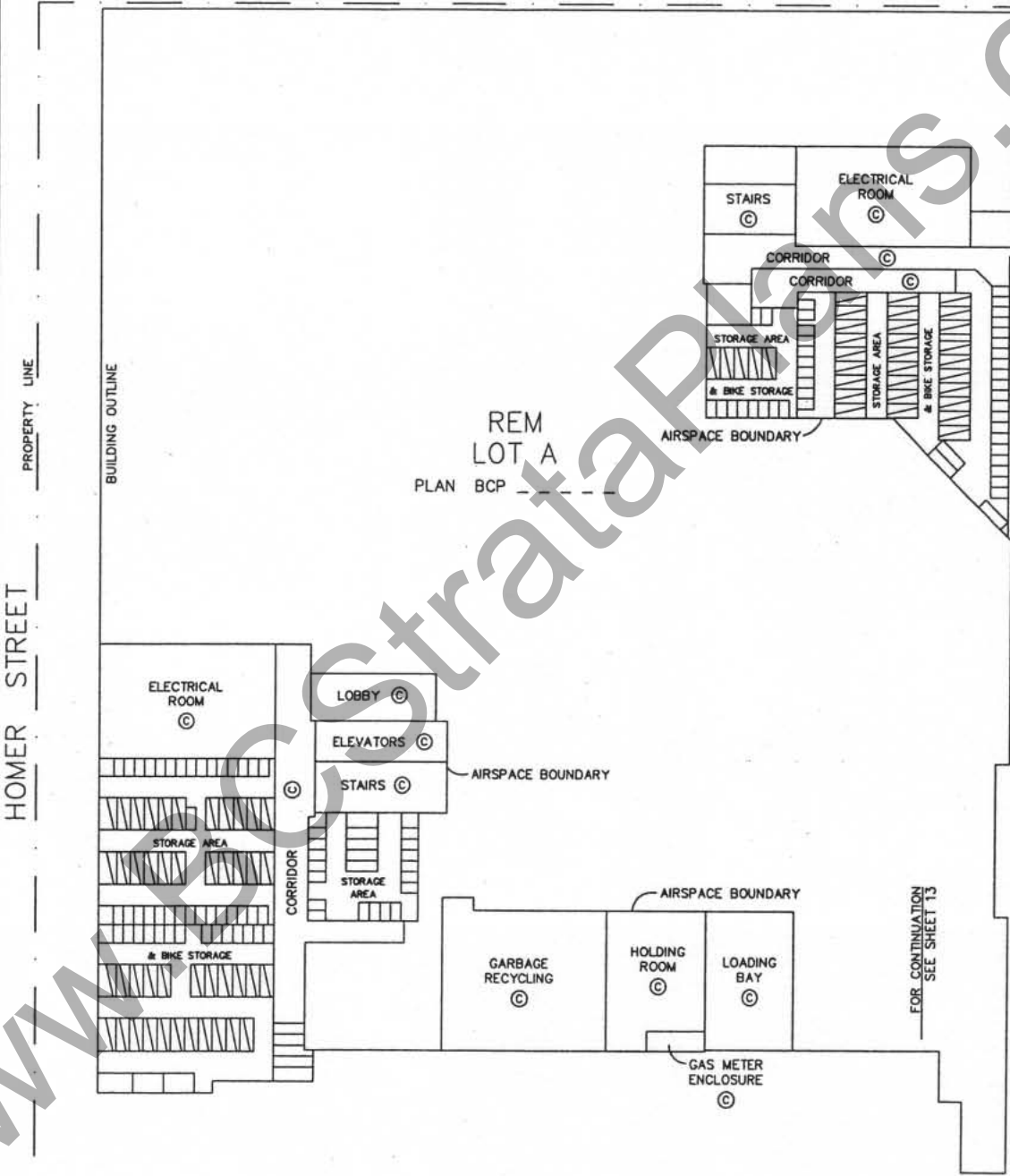

HOMER STREET

BUILDING OUTLINE

REM  
LOT A  
PLAN BCP

PROPERTY LINE

B  
PLAN 4544

REM LOT A  
PLAN BCP

SRW PLAN BCP

FOR CONTINUATION  
SEE SHEET 13

## PARKING - LEVEL 1

**McElhanney**  
 FEBRUARY 16, 2004  
 FILE 2112 06911-12R1

# PARKING LEVEL 1 AND MAINLAND TOWER 2 - LEVEL 1

STRATA PLAN BCS \_\_\_\_\_

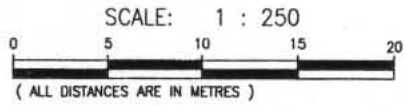

SEE SHEET 12  
FOR CONTINUATION

## SMITHE STREET

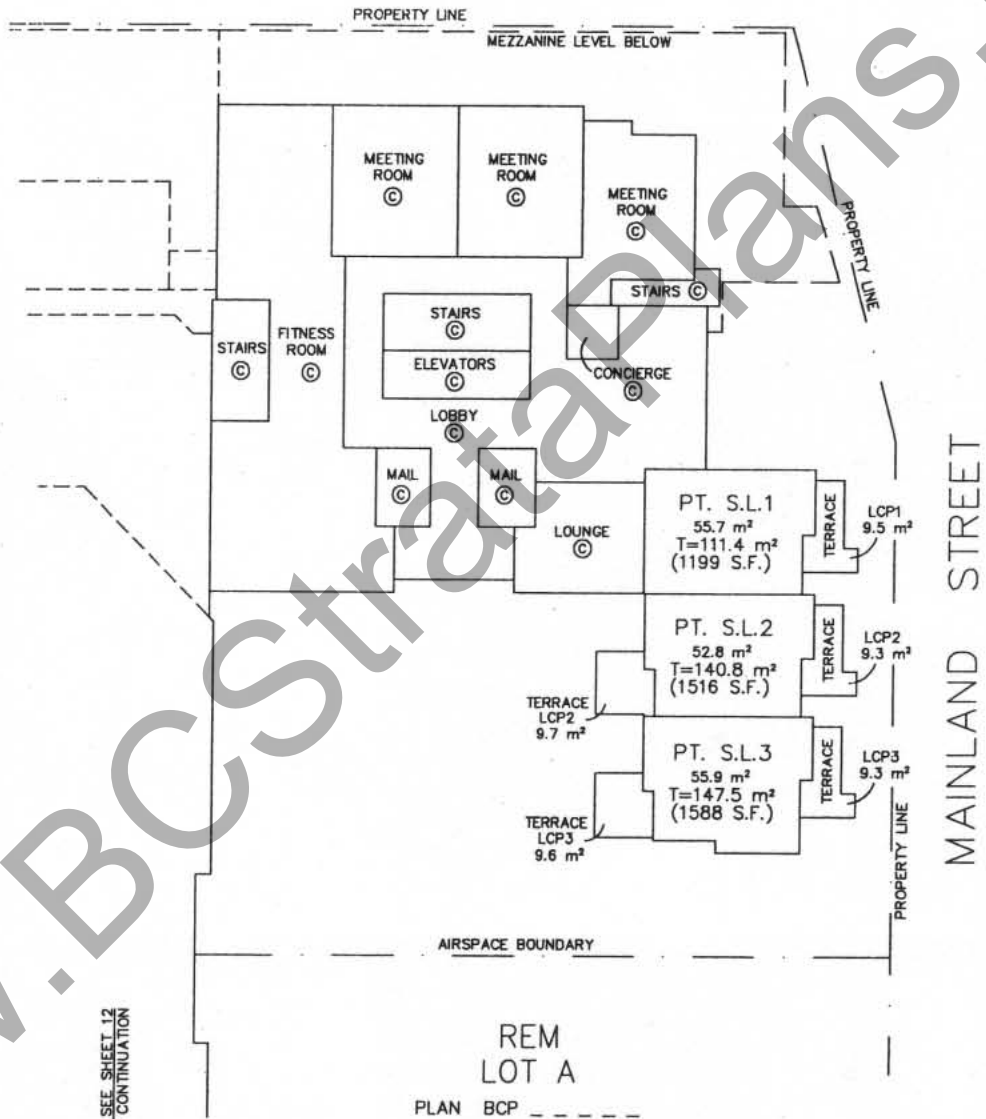

SEE SHEET 12  
FOR CONTINUATION

# MAINLAND TOWER 2 - LEVEL 1



**McElhanney**  
 FEBRUARY 16, 2004  
 FILE 2112 06911-12R1

# HOMER TOWER 1 - LEVEL 1 AND MAINLAND TOWER 2 - LEVEL 2

STRATA PLAN BCS \_\_\_\_\_

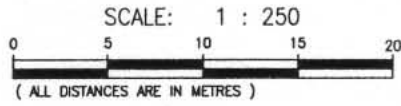

SEE SHEET 14  
FOR CONTINUATION

SMITHE STREET

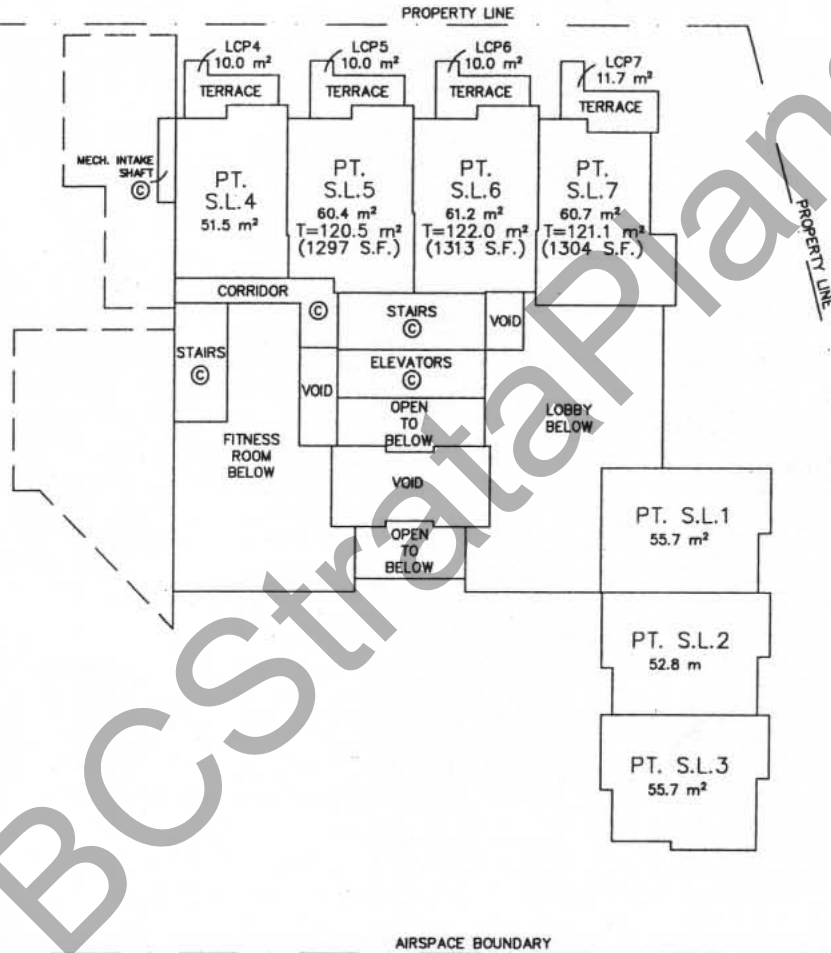

SEE SHEET 14  
FOR CONTINUATION

MAINLAND TOWER 2 - LEVEL 2



**McElhanney**

FEBRUARY 16, 2004  
FILE 2112 06911-12R1



# HOMER TOWER 1 - LEVEL 2 AND MAINLAND TOWER 2 - LEVEL 3

STRATA PLAN BCS \_\_\_\_\_

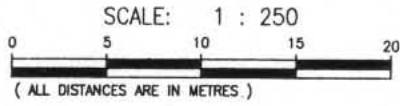

SEE SHEET 16  
FOR CONTINUATION

SMITHE STREET

PROPERTY LINE

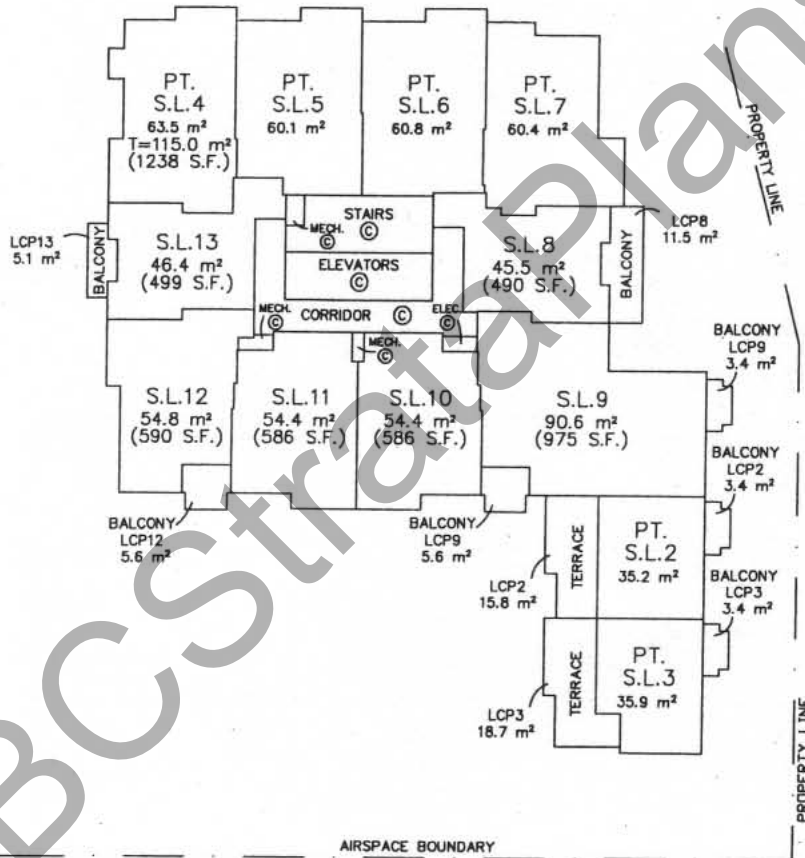

PROPERTY LINE

MAINLAND STREET

PROPERTY LINE

AIRSPACE BOUNDARY

SEE SHEET 16  
FOR CONTINUATION

MAINLAND TOWER 2 - LEVEL 3



**McElhanney**

FEBRUARY 16, 2004  
FILE 2112 06911-12R1

# HOMER TOWER 1 - LEVEL 3 AND MAINLAND TOWER 2 - LEVEL 4

STRATA PLAN BCS \_\_\_\_\_

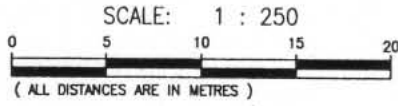

SEE SHEET 18  
FOR CONTINUATION

## SMITHE STREET

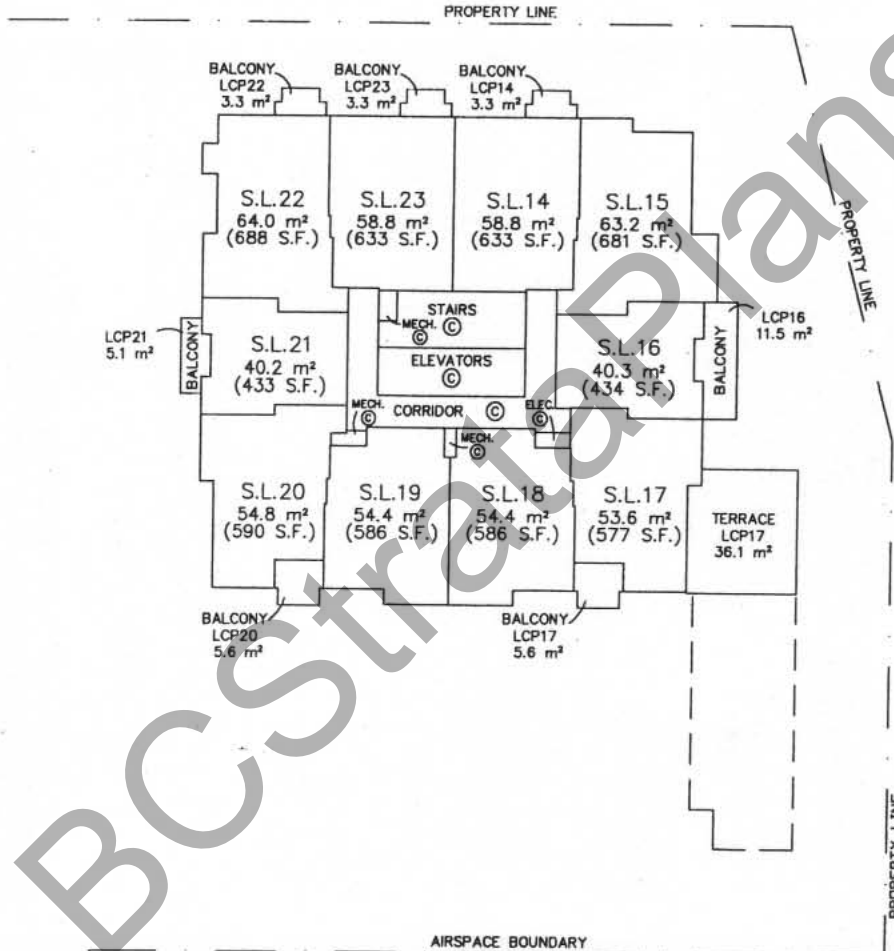

## MAINLAND TOWER 2 - LEVEL 4



**McElhanney**

FEBRUARY 16, 2004  
FILE 2112 06911-12R1

# HOMER TOWER 1 - LEVEL 4 AND MAINLAND TOWER 2 - LEVEL 5

STRATA PLAN BCS \_\_\_\_\_

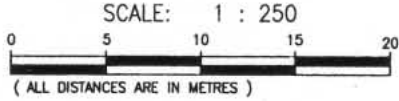

SEE SHEET 20  
FOR CONTINUATION

SMITHE STREET

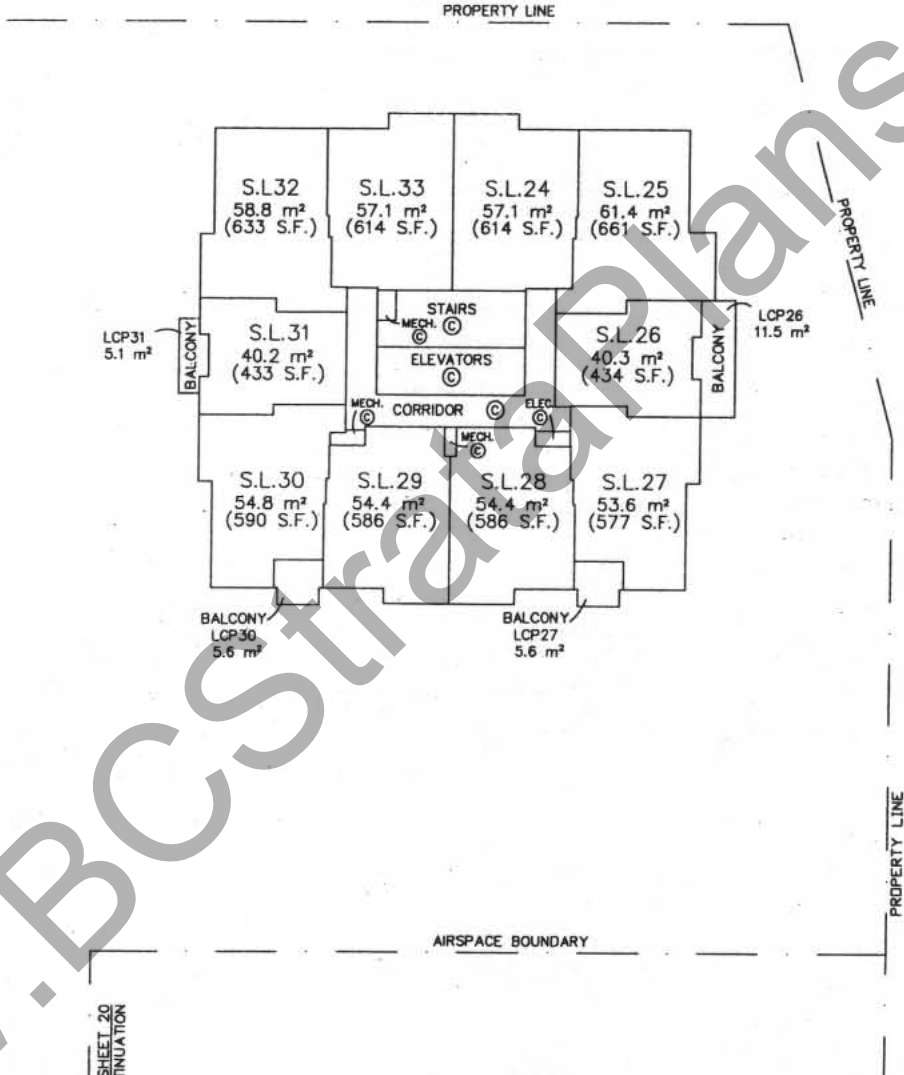

SEE SHEET 20  
FOR CONTINUATION

MAINLAND TOWER 2 - LEVEL 5



**McElhanney**

FEBRUARY 16, 2004  
FILE 2112 06911-12R1

# HOMER TOWER 1 - LEVEL 5 AND MAINLAND TOWER 2 - LEVEL 6

STRATA PLAN BCS \_\_\_\_\_

SCALE: 1 : 250

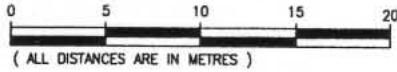

SEE SHEET 22  
FOR CONTINUATION

## SMITHE STREET

PROPERTY LINE

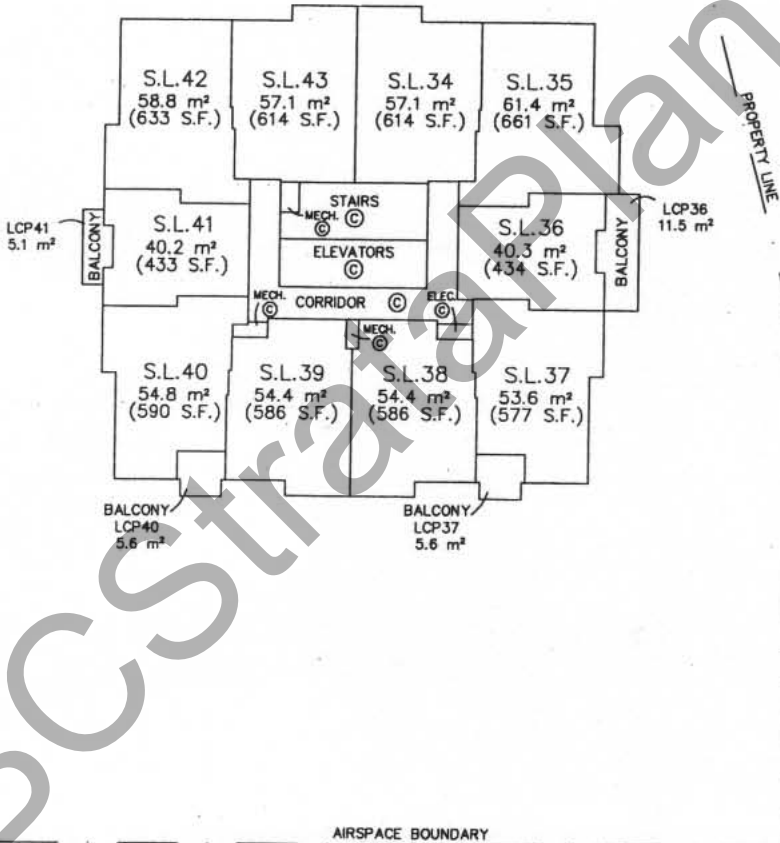

## MAINLAND STREET

PROPERTY LINE

AIRSPACE BOUNDARY

SEE SHEET 22  
FOR CONTINUATION

# MAINLAND TOWER 2 - LEVEL 6



**McElhanney**

FEBRUARY 16, 2004

FILE 2112 06911-12R1

SCALE: 1 : 250

0 5 10 15 20

( ALL DISTANCES ARE IN METRES )

SMITHE STREET

PROPERTY LINE

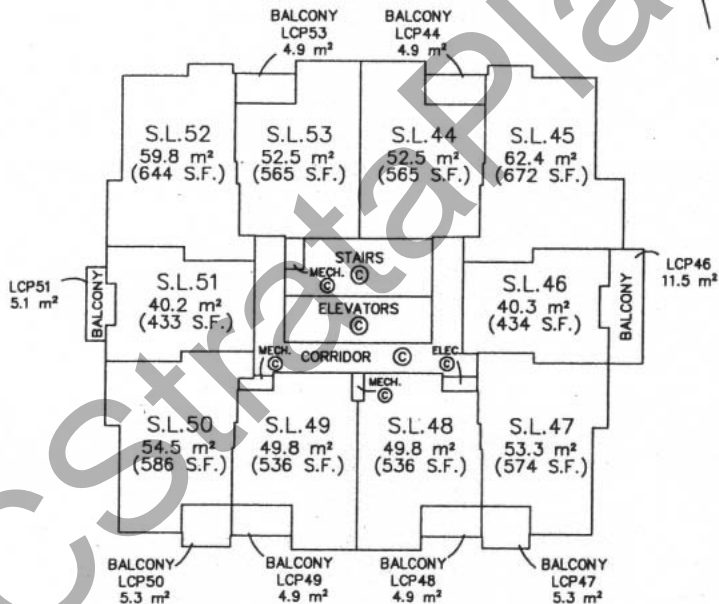

PROPERTY LINE

MAINLAND STREET

MAINLAND TOWER 2 - LEVEL 7

SCALE: 1 : 250

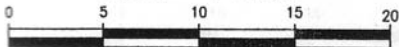

( ALL DISTANCES ARE IN METRES )

SMITHE STREET

PROPERTY LINE

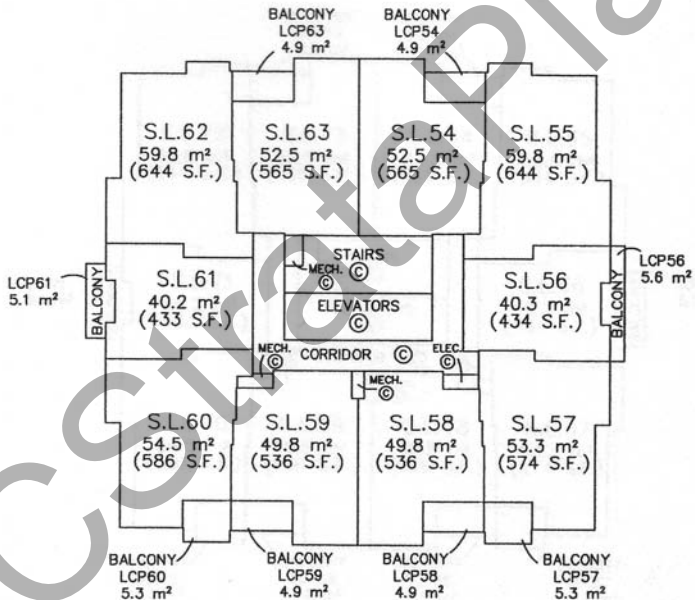

PROPERTY LINE

MAINLAND STREET

MAINLAND TOWER 2 - LEVEL 8

SCALE: 1 : 250

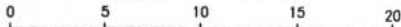

( ALL DISTANCES ARE IN METRES )

SMITHE STREET

PROPERTY LINE

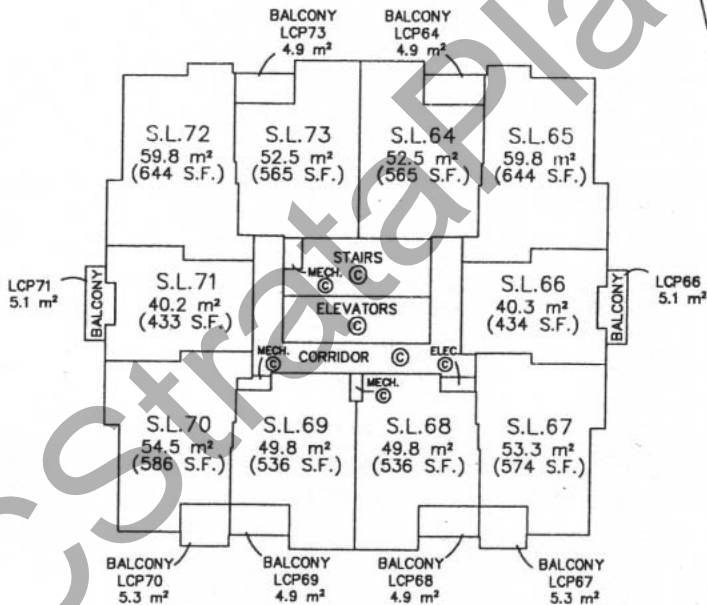

PROPERTY LINE

MAINLAND STREET

MAINLAND TOWER 2 - LEVEL 9

SCALE: 1 : 250

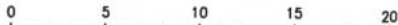

( ALL DISTANCES ARE IN METRES )

SMITHE STREET

PROPERTY LINE

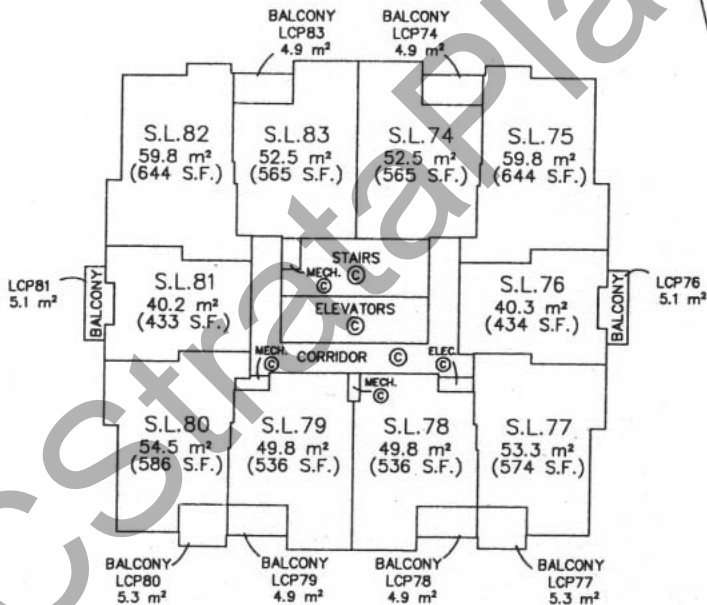

PROPERTY LINE

MAINLAND STREET

MAINLAND TOWER 2 - LEVEL 10



SCALE: 1 : 250



( ALL DISTANCES ARE IN METRES )

SMITHE STREET

PROPERTY LINE

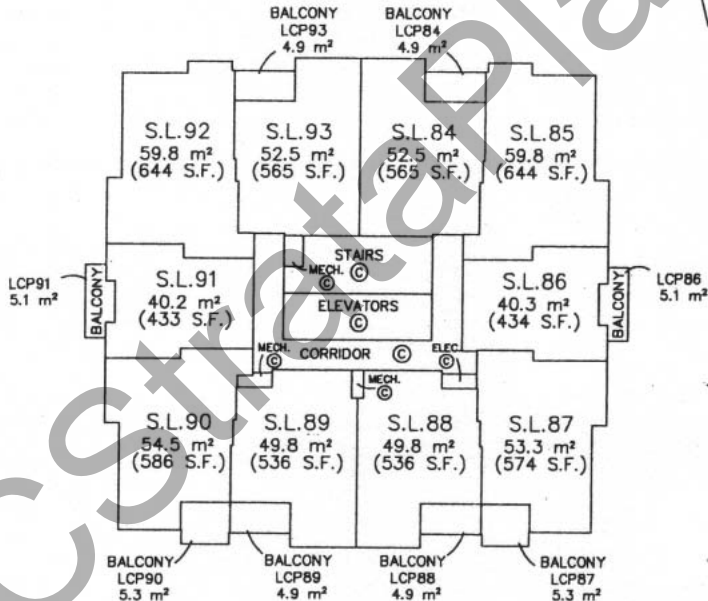

PROPERTY LINE

MAINLAND STREET

MAINLAND TOWER 2 - LEVEL 11

SCALE: 1 : 250

0 5 10 15 20

( ALL DISTANCES ARE IN METRES )

SMITHE STREET

PROPERTY LINE

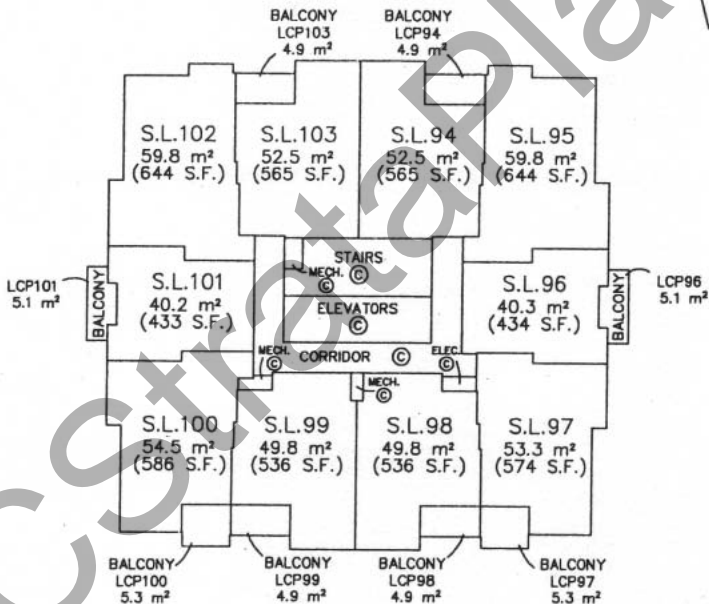

PROPERTY LINE

MAINLAND STREET

MAINLAND TOWER 2 - LEVEL 12

SCALE: 1 : 250

0 5 10 15 20

( ALL DISTANCES ARE IN METRES )

SMITHE STREET

PROPERTY LINE

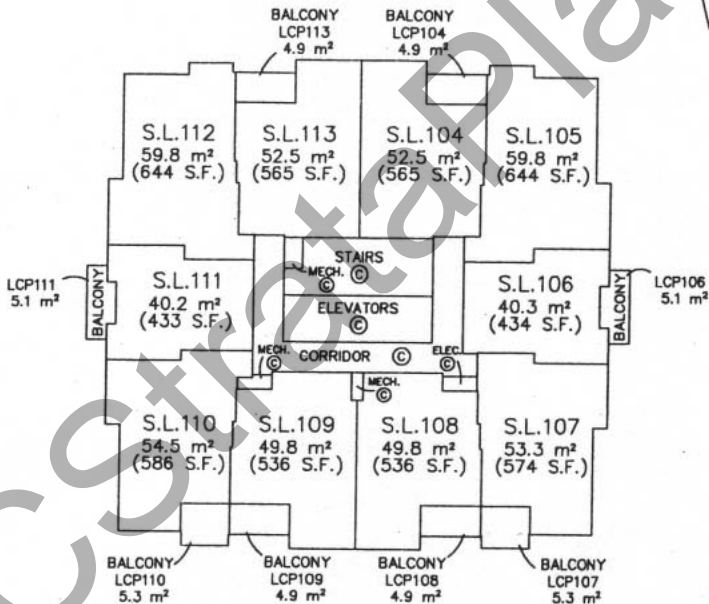

PROPERTY LINE

MAINLAND STREET

MAINLAND TOWER 2 - LEVEL 13

SCALE: 1 : 250

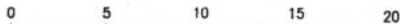

( ALL DISTANCES ARE IN METRES )

SMITHE STREET

PROPERTY LINE

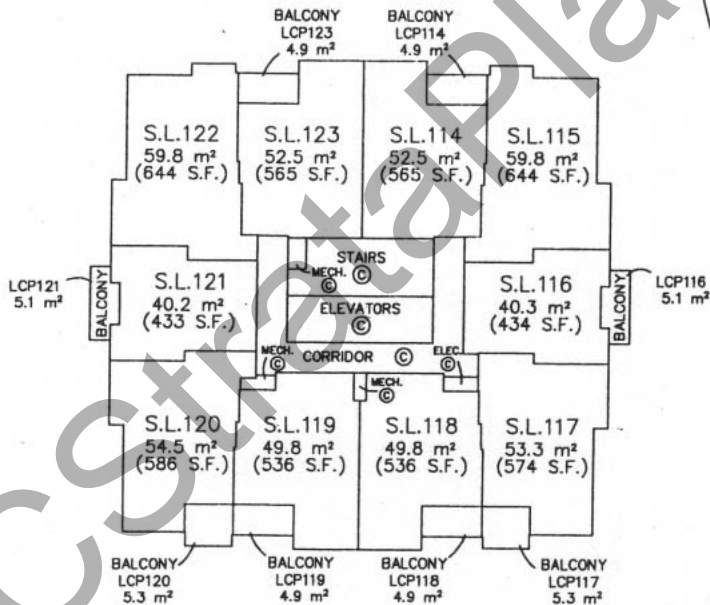

PROPERTY LINE

MAINLAND STREET

MAINLAND TOWER 2 - LEVEL 14

SCALE: 1 : 250

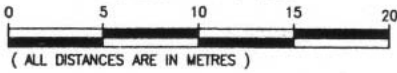

SMITHE STREET

PROPERTY LINE

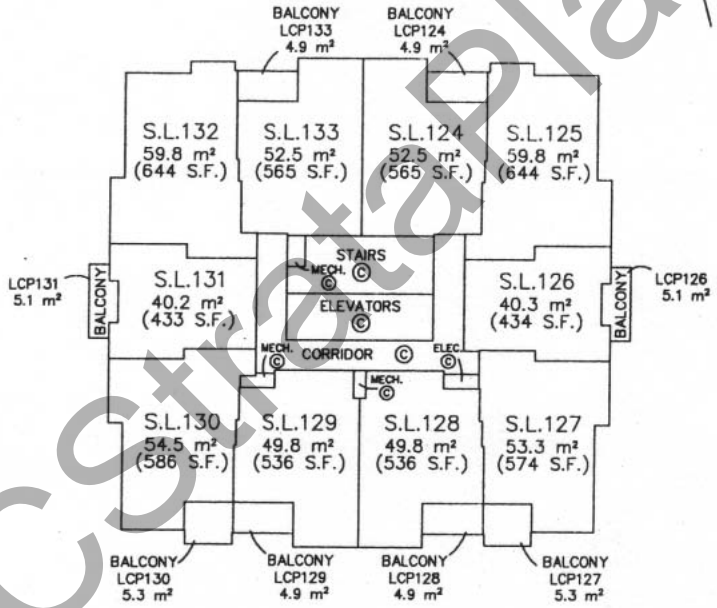

PROPERTY LINE

MAINLAND STREET

MAINLAND TOWER 2 - LEVEL 15

SCALE: 1 : 250

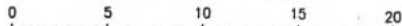

( ALL DISTANCES ARE IN METRES )

SMITHE STREET

PROPERTY LINE

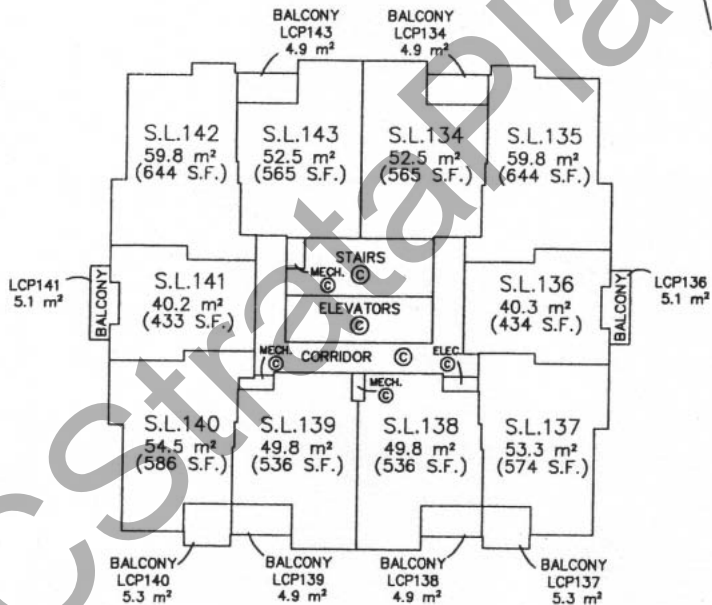

PROPERTY LINE

MAINLAND STREET

MAINLAND TOWER 2 - LEVEL 16

SCALE: 1 : 250

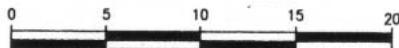

( ALL DISTANCES ARE IN METRES )

SMITHE STREET

PROPERTY LINE

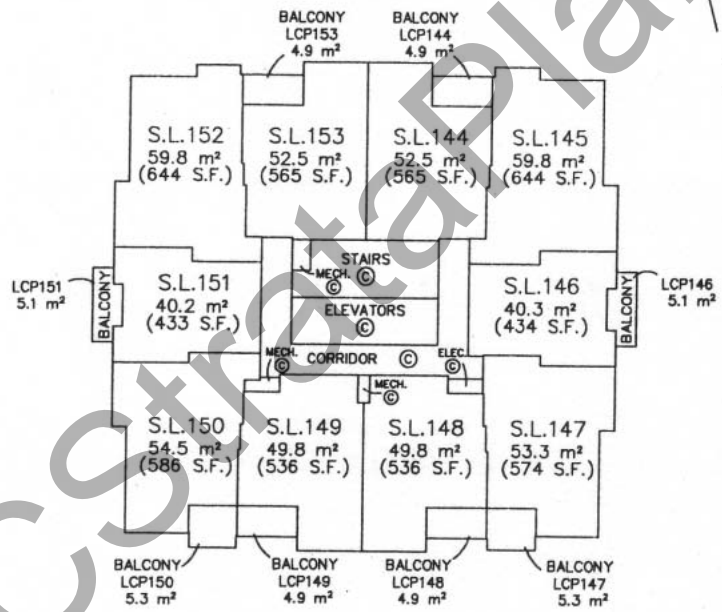

PROPERTY LINE

MAINLAND STREET

MAINLAND TOWER 2 - LEVEL 17

SCALE: 1 : 250

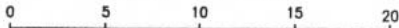

( ALL DISTANCES ARE IN METRES )

SMITHE STREET

PROPERTY LINE

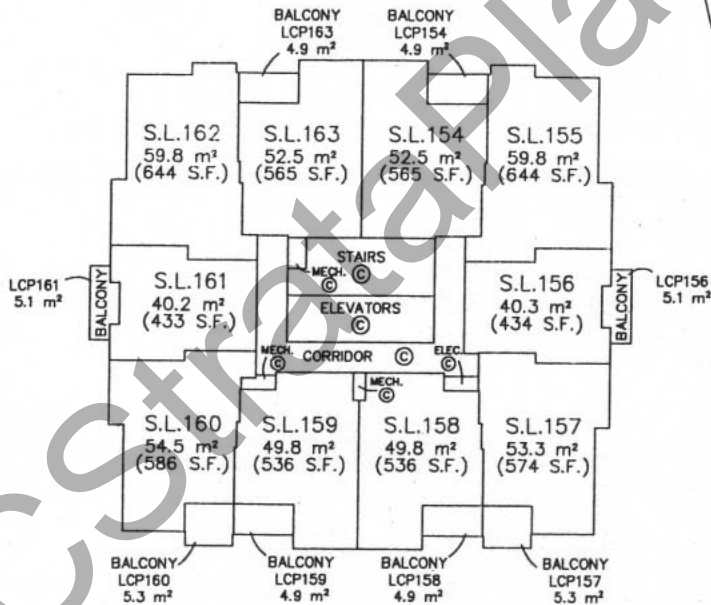

PROPERTY LINE

MAINLAND STREET

MAINLAND TOWER 2 - LEVEL 18



SCALE: 1 : 250

0 5 10 15 20

( ALL DISTANCES ARE IN METRES )

SMITHE STREET

PROPERTY LINE

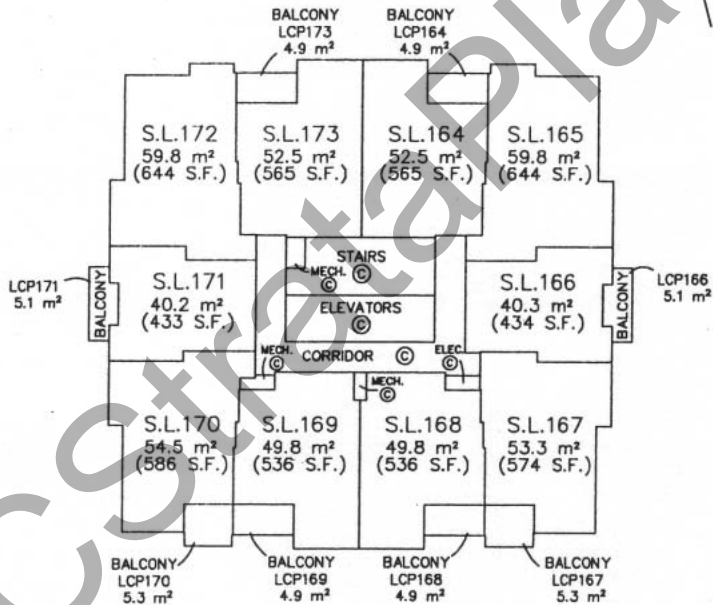

PROPERTY LINE

MAINLAND STREET

MAINLAND TOWER 2 - LEVEL 19

SCALE: 1 : 250

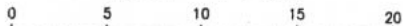

( ALL DISTANCES ARE IN METRES )

SMITHE STREET

PROPERTY LINE

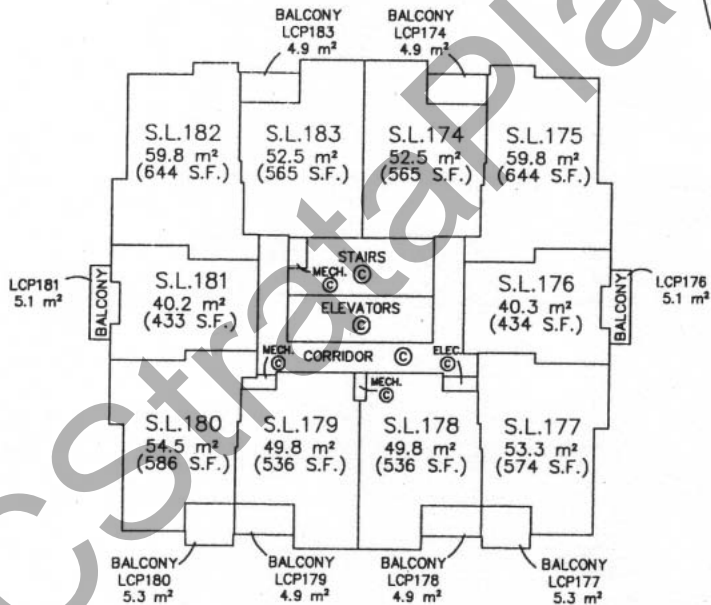

PROPERTY LINE

MAINLAND STREET

MAINLAND TOWER 2 - LEVEL 20

SCALE: 1 : 250

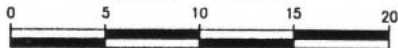

( ALL DISTANCES ARE IN METRES )

SMITHE STREET

PROPERTY LINE

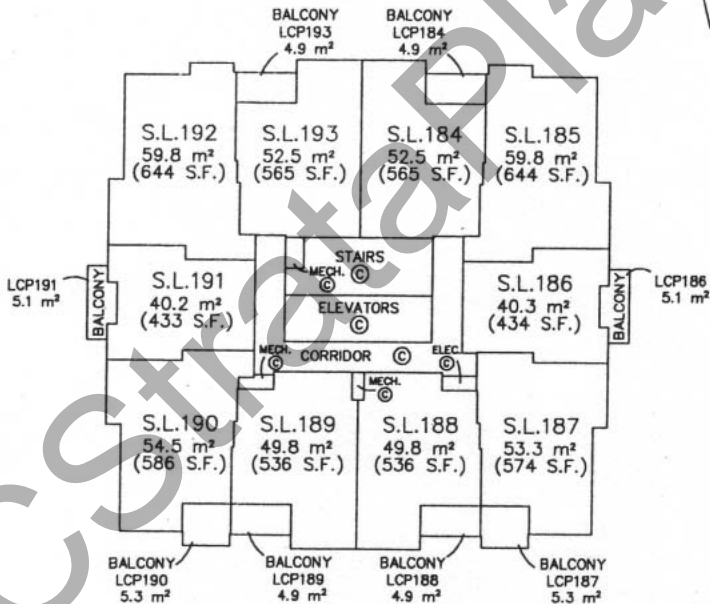

PROPERTY LINE

MAINLAND STREET

MAINLAND TOWER 2 - LEVEL 21

SCALE: 1 : 250

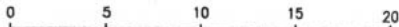

( ALL DISTANCES ARE IN METRES )

SMITHE STREET

PROPERTY LINE

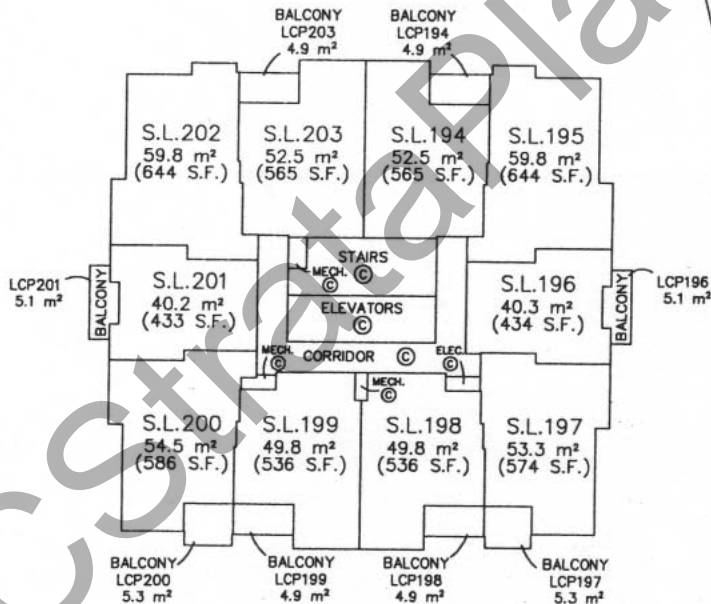

PROPERTY LINE

MAINLAND STREET

MAINLAND TOWER 2 - LEVEL 22

SCALE: 1 : 250



( ALL DISTANCES ARE IN METRES )

SMITHE STREET

PROPERTY LINE

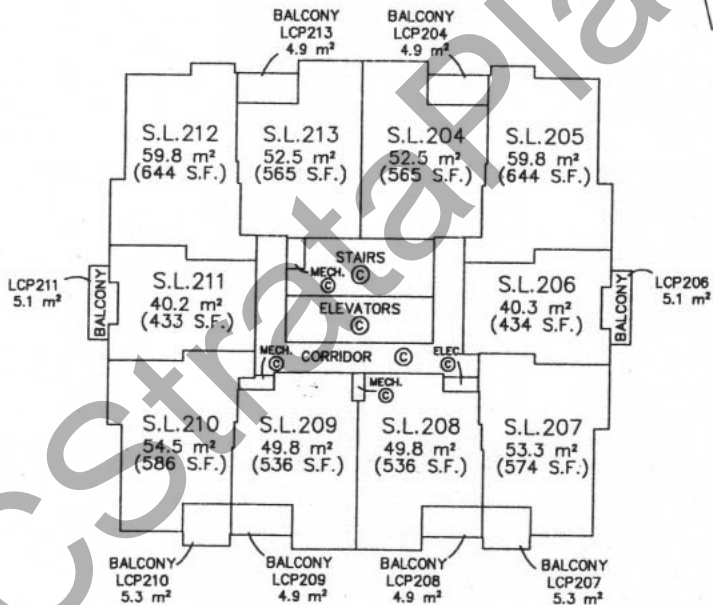

PROPERTY LINE

MAINLAND STREET

MAINLAND TOWER 2 - LEVEL 23

SCALE: 1 : 250

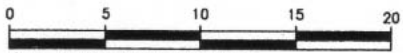

( ALL DISTANCES ARE IN METRES )

SMITHE STREET

PROPERTY LINE

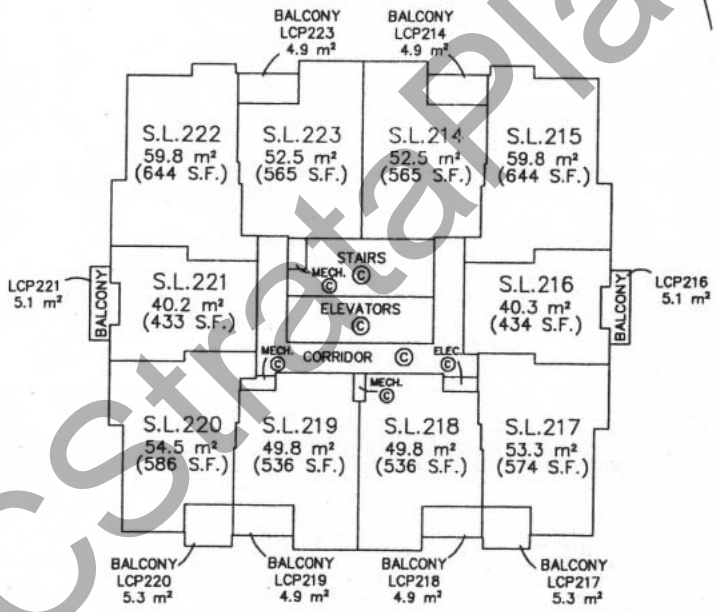

PROPERTY LINE

MAINLAND STREET

MAINLAND TOWER 2 - LEVEL 24

SCALE: 1 : 250

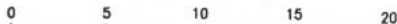

( ALL DISTANCES ARE IN METRES )

SMITHE STREET

PROPERTY LINE

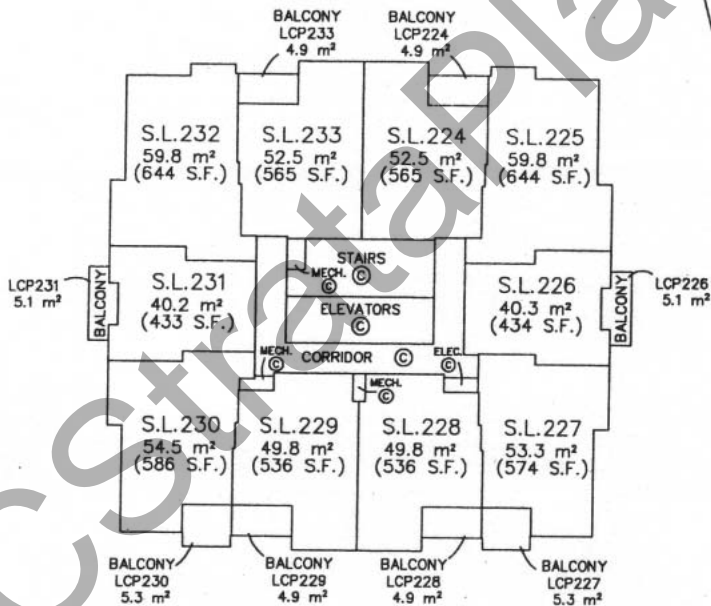

PROPERTY LINE

MAINLAND STREET

MAINLAND TOWER 2 - LEVEL 25

SCALE: 1 : 250

0 5 10 15 20

( ALL DISTANCES ARE IN METRES )

SMITHE STREET

PROPERTY LINE

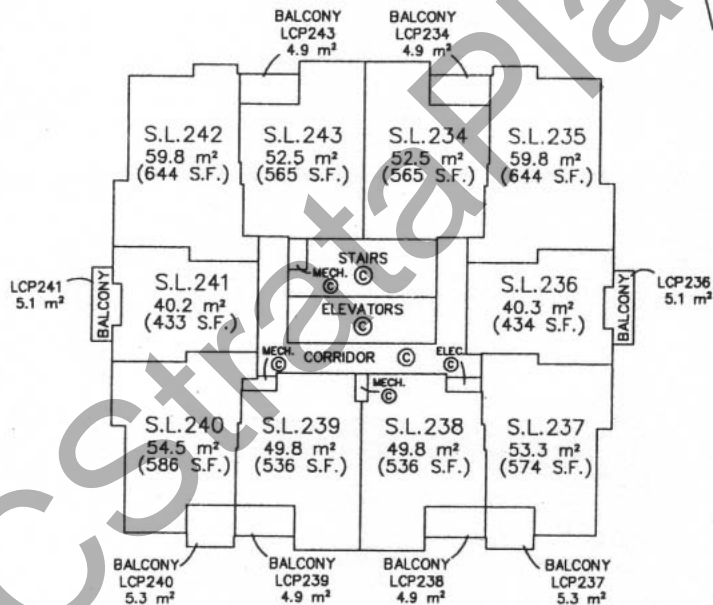

PROPERTY LINE

MAINLAND STREET

MAINLAND TOWER 2 - LEVEL 26



SCALE: 1 : 250

0 5 10 15 20

( ALL DISTANCES ARE IN METRES )

SMITHE STREET

PROPERTY LINE

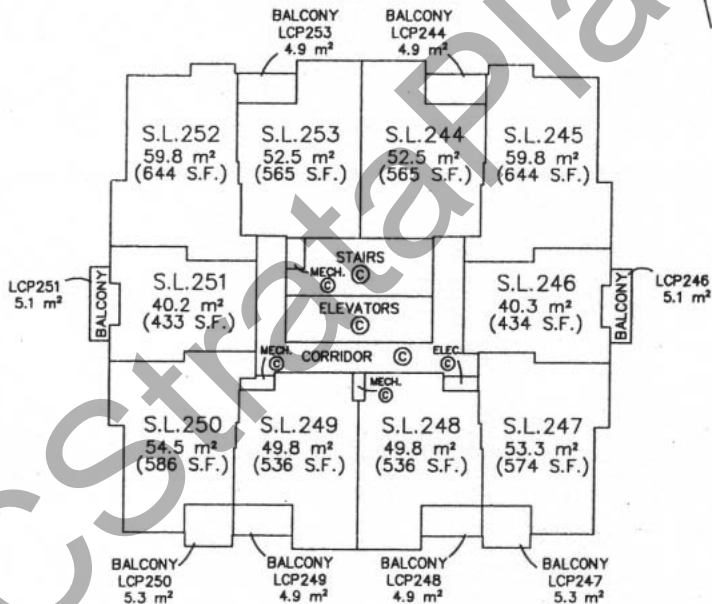

PROPERTY LINE

MAINLAND STREET

MAINLAND TOWER 2 - LEVEL 27

SCALE: 1 : 250

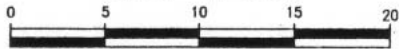

( ALL DISTANCES ARE IN METRES )

SMITHE STREET

PROPERTY LINE

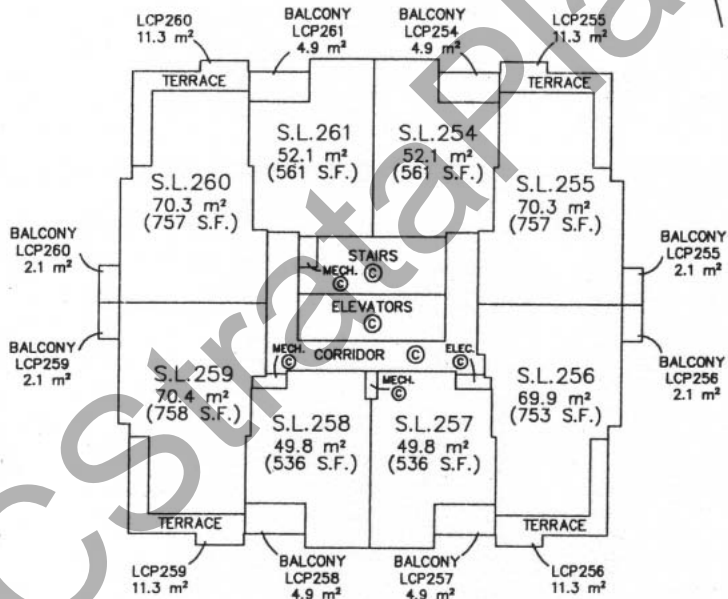

PROPERTY LINE

MAINLAND STREET

MAINLAND TOWER 2 - LEVEL 28

SCALE: 1 : 250

0 5 10 15 20

( ALL DISTANCES ARE IN METRES )

SMITHE STREET

PROPERTY LINE

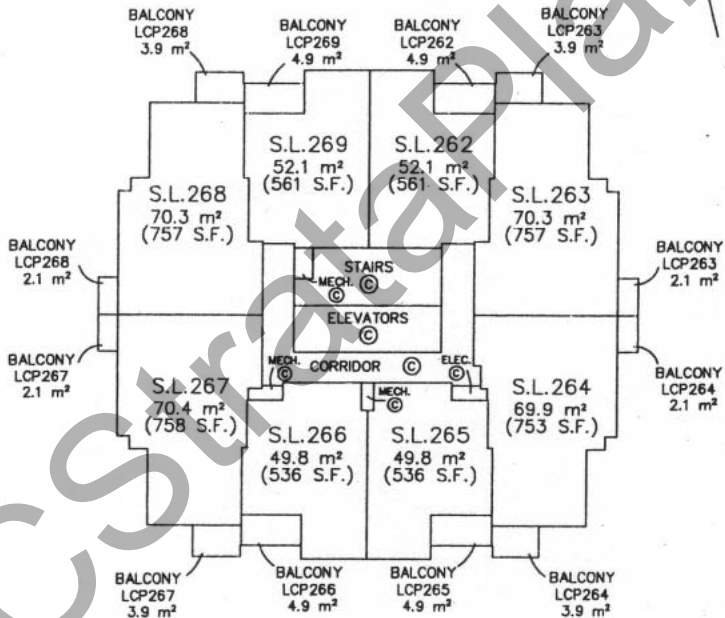

PROPERTY LINE

MAINLAND STREET

MAINLAND TOWER 2 - LEVEL 29

SCALE: 1 : 250



( ALL DISTANCES ARE IN METRES )

SMITHE STREET

PROPERTY LINE

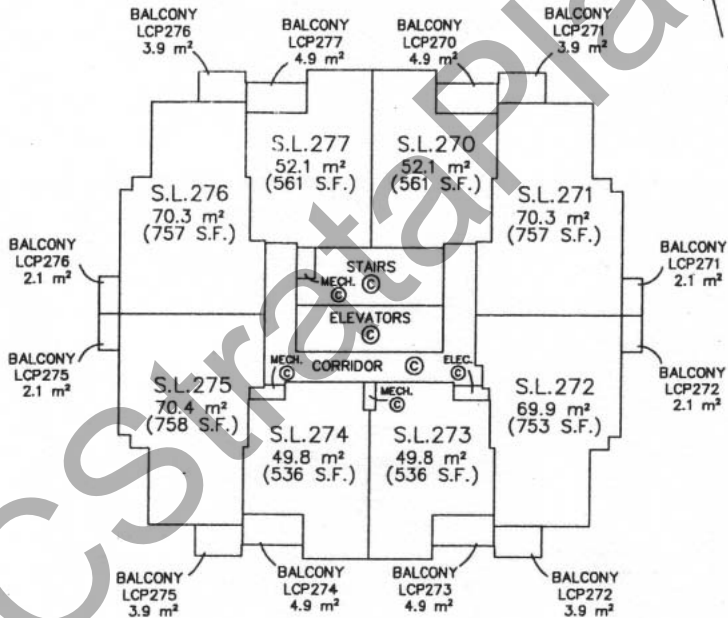

PROPERTY LINE

MAINLAND STREET

MAINLAND TOWER 2 - LEVEL 30

SCALE: 1 : 250

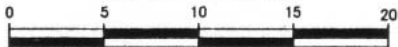

( ALL DISTANCES ARE IN METRES )

SMITHE STREET

PROPERTY LINE

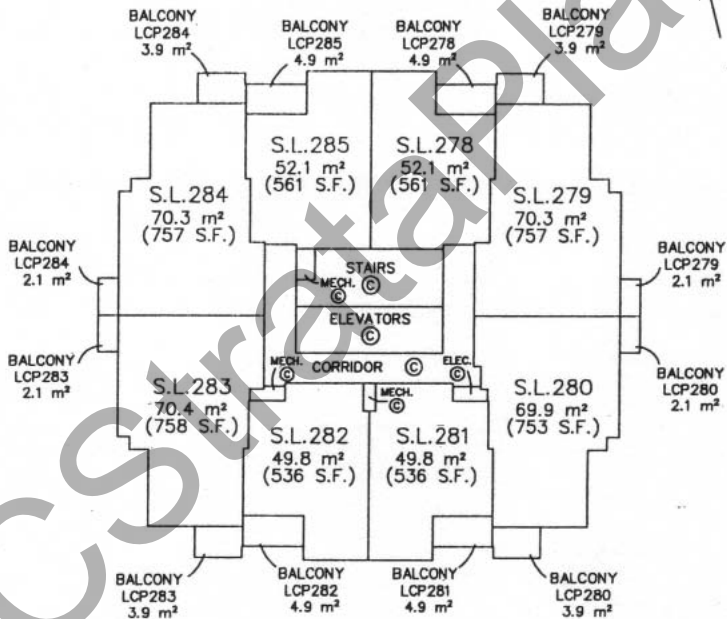

PROPERTY LINE

MAINLAND STREET

MAINLAND TOWER 2 - LEVEL 31

SCALE: 1 : 250

0 5 10 15 20

( ALL DISTANCES ARE IN METRES )

SMITHE STREET

PROPERTY LINE

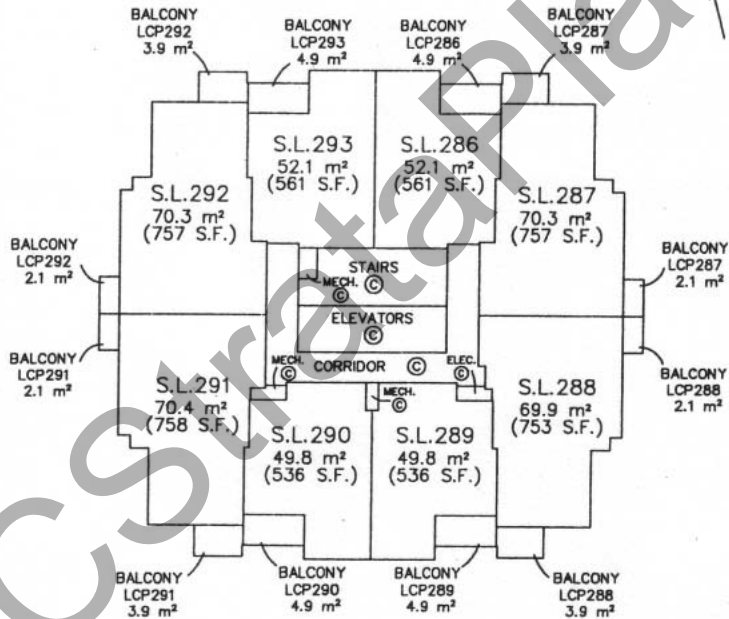

PROPERTY LINE

MAINLAND STREET

MAINLAND TOWER 2 - LEVEL 32

SCALE: 1 : 250

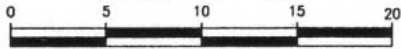

( ALL DISTANCES ARE IN METRES )

SMITHE STREET

PROPERTY LINE

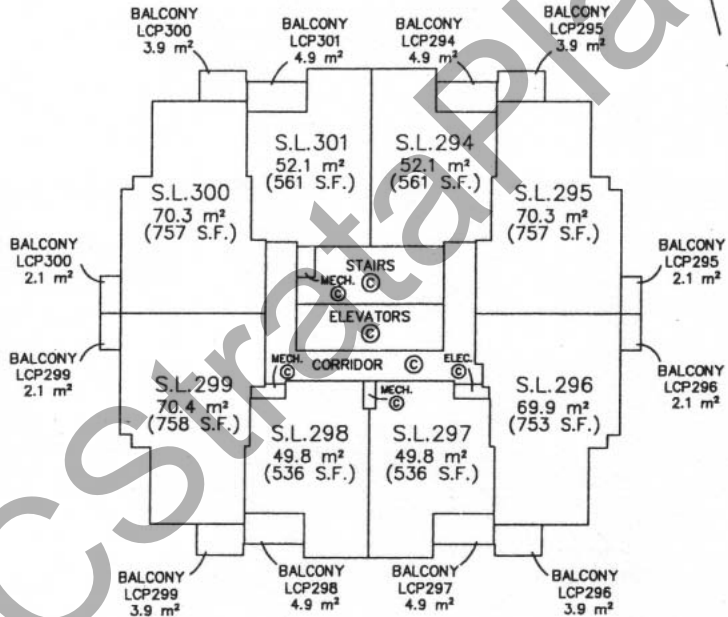

PROPERTY LINE

MAINLAND STREET

MAINLAND TOWER 2 - LEVEL 33

SCALE: 1 : 250

0 5 10 15 20

( ALL DISTANCES ARE IN METRES )

SMITHE STREET

PROPERTY LINE

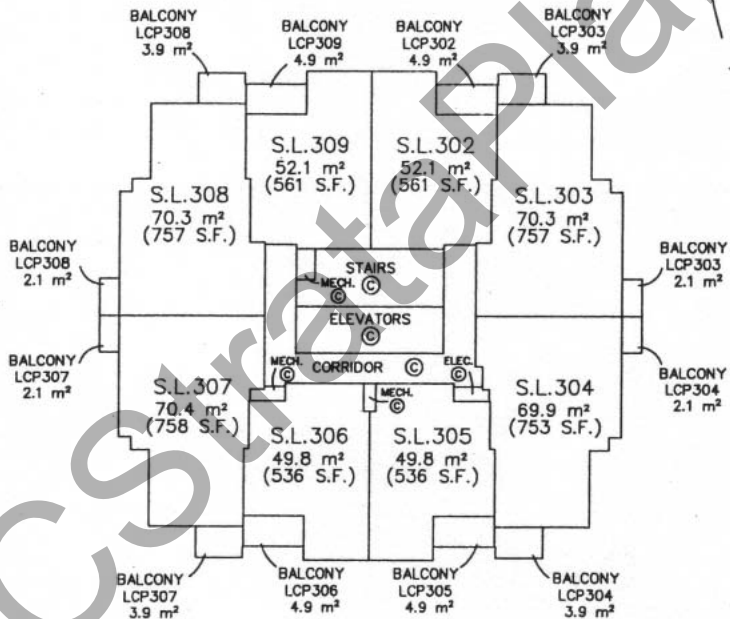

PROPERTY LINE

MAINLAND STREET

MAINLAND TOWER 2 - LEVEL 34